

# Basic Structural Considerations

## Introduction

- Bridge members must be able to carry the loads applied to them.
- This presentation considers:
  - how loads are applied to members
  - how bridge members are stressed by loads
  - how bridge materials resist stress

## Beams

- Different member types carry load in different ways.
- Beams are members which are loaded perpendicular to their length.
- They are also referred to as stringers and girders.

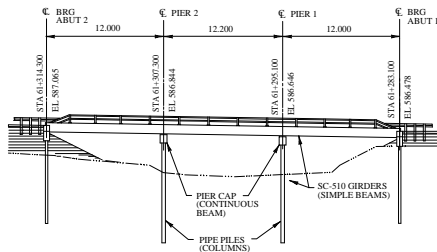

ELEVATION

## Simple Beams

- Shown below is a Free Body Diagram of a simple beam.

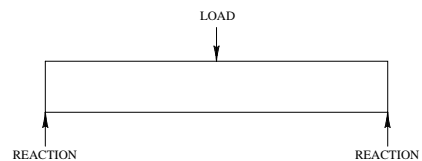

- In this diagram arrows are used to show the forces (loads and reactions) acting on the beam.
- These arrows are drawn at the points the forces are applied and in the directions they act.
- Reactions are the forces that support a member.
- They are exerted by other members or by the ground.

## Continuous Beams

- A continuous beam is a beam that is supported at intermediate points along its length.

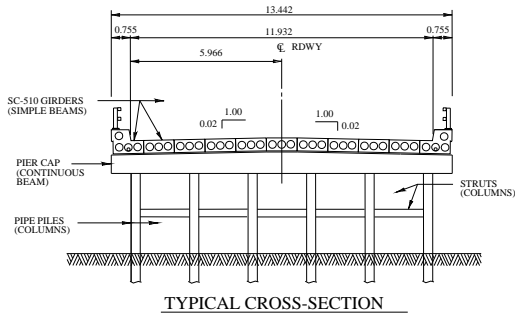

## Continuous Beams

- Shown below is a Free Body Diagram of a continuous beam.

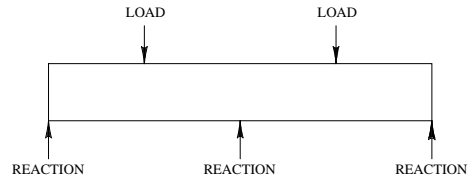

- The addition of intermediate supports allows a beam to carry more load.

## Columns and Hangers

- Columns and hangers are members which are loaded parallel to their length.
- Columns are loaded in compression; hangers in tension.

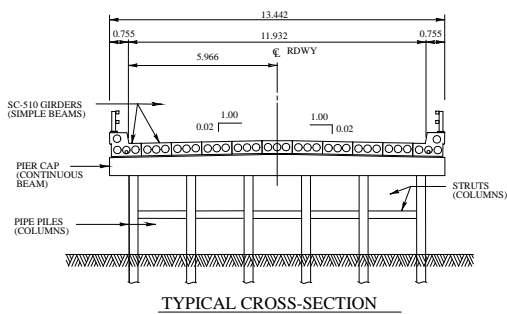

## Columns and Hangers

- Shown below are Free Body Diagrams for a column and a hanger.



Column



Hanger

## Stresses

- Loads cause stresses in a member.
- Stresses are the internal forces that the member experiences at its different locations.
- Stress has units of Force/Area e.g. kips per square inch (ksi), Newtons per square millimetre (MPa).
- The following types of stress occur in bridge members:
  - tension stress
  - compression stress
  - bending stress
  - shear stress

## Hangers - Tension Stress

- Below is a Free Body Diagram of a hanger as well as of a piece cut out from the hanger.
- What stresses must be present at the cuts to keep the pieces of the hanger from separating?
- The stresses are the same at each location and try to lengthen the hanger.

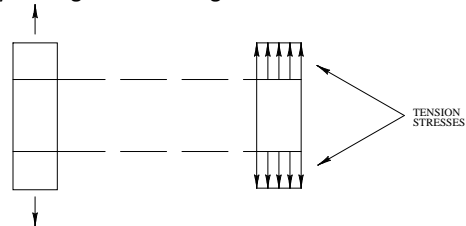

## Columns - Compression Stress

- Below is a Free Body Diagram of a column as well as of a piece cut out from the column.
- What stresses must be present at the cuts to keep the pieces of the column apart?
- The stresses are the same at each location and try to shorten the column.

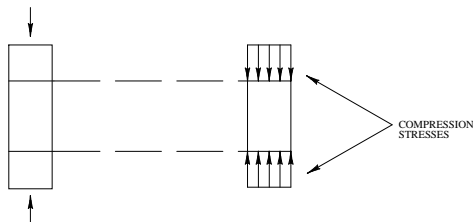

## Columns - Buckling

- Compression stresses can also cause buckling of a column.
- Slender columns buckle easier than stocky ones.
- Misaligned columns buckle easier than straight ones.

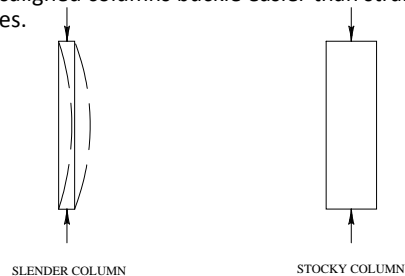

## Simple Beams - Curvature

- Bending stresses caused curvature of the beam.
- The larger the curvature; the larger the bending stresses.
- The curvature causes sections of the beam to rotate.
- Simple beams go into positive curvature.

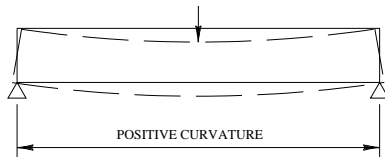

SIMPLE BEAM CURVATURE

## Continuous Beams - Curvature

- Continuous beams go into both positive and negative curvature.

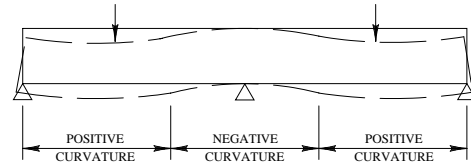

CONTINUOUS BEAM CURVATURE

- Curvature is generally positive away from intermediate supports with maximum positive curvatures occurring beneath the loads.
- Curvature is generally negative near intermediate supports with maximum negative curvatures occurring at intermediate supports.

## Simple Beams - Bending Stress

- Below is a Free Body Diagram showing a section of beam in positive curvature.

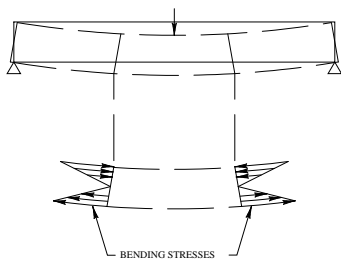

- The top of the beam is being pushed together (compression) while the bottom of the beam is being pulled apart (tension).
- The mid-height of the beam does not change length and is not stressed.

## Continuous Beams - Bending Stress

- Below is a Free Body Diagram showing a section of beam in negative curvature.

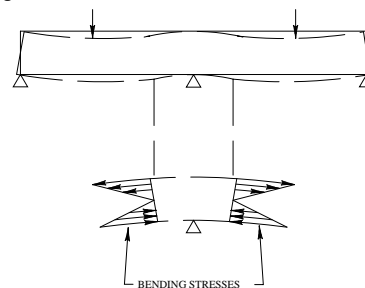

- The top of the beam is being pulled apart (tension) while the bottom of the beam is being pushed together (compression).
- The mid-height of the beam does not change length and is not stressed.

## Beams - Horizontal Shear Stress

- Horizontal shear stress is caused by beam curvature.
- Below are two beams in bending, one on top of the other.
- The bottom of the top beam lengthens while the top of the bottom beam shortens causing the beams to slide past each other.

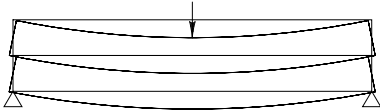

- If the two beams become one beam sliding can no longer occur.

## Beams - Horizontal Shear Stress

- Below are two Free Body Diagrams showing the horizontal shear stresses required to prevent sliding along a longitudinal cut of a beam in positive curvature.

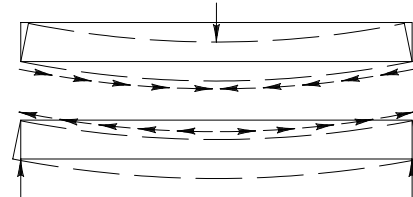

HORIZONTAL SHEAR STRESSES

## Beams - Vertical Shear Stress

- Below is a Free Body Diagram of a piece of beam.
- Shear stress must be present at the vertical cuts to keep the pieces of the beam from sliding past each other.

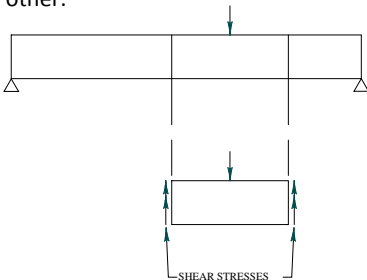

SHEAR STRESSES

## Beams - Vertical Shear Stress

- Below is a Free Body Diagram of a different piece of the same beam.
- Tension stresses must be present at the inclined cuts to keep the pieces of the beam from separating.

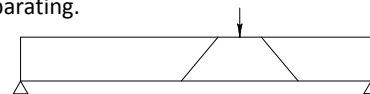

TENSION STRESSES

## Stress In Steel

- Different bridge materials respond to stress in different ways.
- Shown below is a stress-strain diagram for steel.
- Strain is a measure of the stretching or shortening of a member under stress.

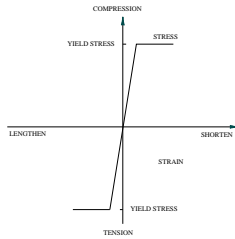

- Steel is strong in both tension and compression.
- Steel that has reached its yield stress lengthens or shortens under constant stress.

## Stress In Steel

- An important property to remember when inspecting bridges is that a steel bending member that has reached its yield stress will develop a kink or sag.
- A beam that has developed a kink and sagged is shown below.

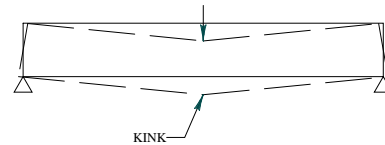

## Stress In Steel

- Steel members are normally made up of slender components (flanges and webs).
- Therefore steel compression members (including parts of beams in compression) are susceptible to buckling.
- Misalignment of a member in compression lowers the load at which it buckles.

## Stress In Concrete

- Shown below is a stress-strain diagram for concrete.

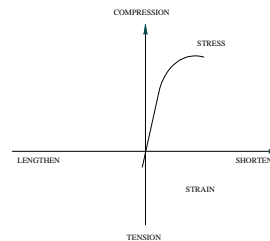

- Concrete is strong in compression and weak in tension.

### Stress In Concrete

- An unreinforced concrete beam will fail in tension under a small load.

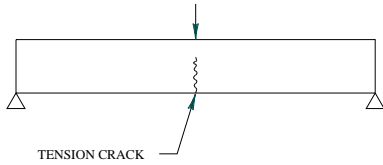

### Stress In Concrete

- Reinforcing steel placed on the tension side of a beam increases its strength.

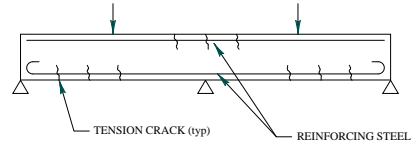

- Cracking of the concrete may still occur but the reinforcing steel acting in tension prevents failure.
- Cracks caused by bending stresses occur in the middle of the span near the bottom of the beam or at intermediate supports near the top of the beam.
- These vertical cracks are normal unless they have opened up indicating that the reinforcing steel has yielded.

### Stress In Concrete

- High strength steel is sometimes used to control concrete cracking caused by bending stresses.
- The high strength steel is stretched and the concrete beam cast around it.

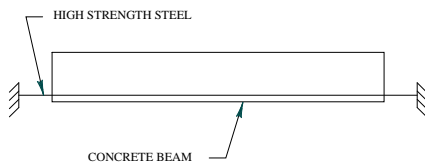

- When the concrete has gained adequate strength the high strength steel is cut.

### Stress In Concrete

- Shown below is a concrete beam after the high strength steel has been cut.



- The cutting of the high strength steel results in the steel and also the bottom of the beam shortening and going into compression counteracting the tension caused by the loads and delaying cracking.

### Stress In Concrete

- Shear in an unreinforced concrete beam can cause an inclined crack to form resulting in sudden failure.

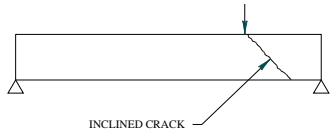

- Stirrups placed across the inclined tension crack increase the shear strength above the concrete cracking strength thus giving warning of failure.

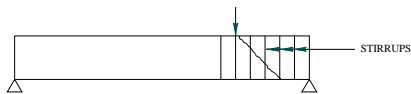

- It is important to report inclined cracking in a beam as the opening up of an inclined crack can result in sudden failure of the beam.

### Stress In Timber

- Timber is a “natural” material and has different strength properties in different directions.
- Its internal structure can be thought of as a bundle of straws running in the direction of the grain.

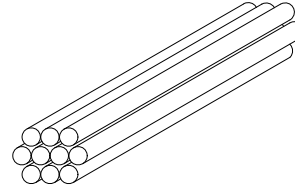

### Stress In Timber

- Timber is strong in tension and compression in the direction of the grain.
- Failure due to bending stresses often occurs at a defect such as a knot.

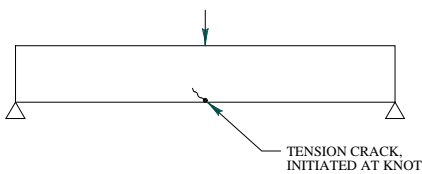

### Stress In Timber

- Timber is weak in shear along the grain just as straws in a bundle easily slide past each other.
- Horizontal cracks caused by horizontal shear stresses can occur at the ends of a timber beam.

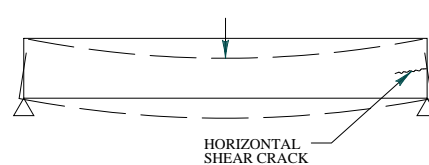



## Stress In Timber

- Timber is weak in compression across the grain just as straws are weak against crushing.

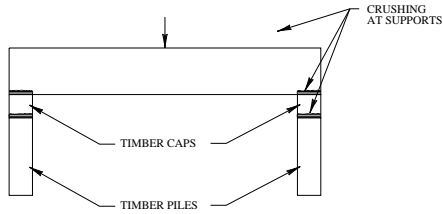

- Crushing can occur where timber caps support beams and also where timber caps are supported by piles.